



MADE IN THE USA

## Fireplaces

United States and Canada

© 2022 LMS

# Owner's Manual



[www.calflamebbq.com](http://www.calflamebbq.com)

LTR50001006, Rev. Q  
10/10/22

# Table of Contents

|  |       |
|--|-------|
| Installation / Assembly .....                        | 5     |
| Placement and Location .....                         | 6     |
| Leak Testing Procedure .....                         | 7     |
| Liquid Propane .....                                 | 8     |
| Propane Cylinder Enclosure .....                     | 10    |
| Natural Gas .....                                    | 12    |
| Fireplace Burner Installation .....                  | 13    |
| Locating Refracter Wall Screws .....                 | 16-18 |
| Fireplace Log Set Placement .....                    | 19    |
| High Elevation Conversion .....                      | 20    |
| Natural Gas Conversion .....                         | 20    |
| Operation .....                                      | 22    |
| Cleaning and Maintenance .....                       | 25    |
| Replacement Parts .....                              | 26    |
| Specifications .....                                 | 27    |
| Troubleshooting Fireplace and Fire Pit Igniter ..... | 27    |
| Limited Warranty .....                               | 30    |

**Read this before installing  
or operating your  
new Cal Flame fireplace.**



Copyright 2021 LMS. All rights reserved.  
Duplication without written consent is  
strictly prohibited.

Cal Flame ® is a registered trademark.

Due to continuous improvement programs,  
all models, operation, and/or specifications  
are subject to change without prior notice.

LTR50001006, Rev. Q  
10/10/22

**Save these instructions!**

**WARNING!** Proposition 65 Warning:  
Handling the brass material on this  
product exposes you to lead, a chemi-  
cal known to the State of California to  
cause cancer, birth defects or other  
reproductive harm. (Wash hands after  
handling this product.)

This product and the fuels used to op-  
erate this product (propane or natural  
gas), and the products of combus-  
tion of such fuels, can expose you to  
chemicals including Benzene, which  
is known to the state of California to  
cause cancer and birth defects or re-  
productive harm.

For more information go to [www.  
P65Warnings.ca.gov](http://www.P65Warnings.ca.gov).

# Safety Instructions

1

Safety Instructions



**Cal Flame fireplaces are designed for outdoor use only.**



Do not store combustible materials, gasoline and any other flammable vapors and liquids.

A propane gas cylinder not connected for use shall not be stored in the vicinity of this or any other appliance.



**WARNING:** Improper installation, adjustment, alteration, service or maintenance can cause injury or property damage. Read the installation, operating and maintenance instructions thoroughly before installing or servicing this equipment.

## What To Do If You Smell Gas

- Shut off gas to the fireplace.
- Extinguish any open flame.
- Do not try to light the appliance.
- If odor continues, keep away from the appliance and immediately call your gas supplier or your fire department.

## Carbon Monoxide Hazard



This appliance can produce carbon monoxide which has no odor.



Using it in an enclosed space can kill you.

Never use this appliance in an enclosed space such as a camper, tent, car, or home.

## Operation

- **Do not use charcoal or other solid fuel in a gas burning fireplace.**
- Do not operate the fireplace with the propane tank on, near, or under the hearth! This could result in fire, explosion, or severe injury.
- Do not use your fireplace for cooking.
- In the event that a burner goes out, turn burner knobs to the full OFF position and let it air out. Do not attempt to use the fireplace until the gas has had time to dissipate.
- Keep all electrical supply cords away from the heated areas of the fireplace.
- Never use the fireplace in windy conditions. If used in a consistently windy area a windbreak will be required. Always adhere to the specified clearances listed in this manual.
- When handling propane gas line and connectors, do not allow them to come in contact with any metal surfaces. Do not drop propane connectors.
- Propane gas sources to the fireplace must be regulated. Do not operate if regulator has been removed. Fire or explosion can occur.
- Never leave the fireplace unattended when in use.
- Never allow clothing or other flammable materials come in contact with any hot surface until it has fully cooled. Never wear loose fitting or hanging garments while using your fireplace. Fabric may ignite and result in personal injury.
- Clothing or other flammable materials should not be hung from the appliance, or placed on or near the appliance.
- When using the fireplace, do not touch the rock, fire screen, or immediate surroundings, as these areas become extremely hot and could cause burns.
- Do not heat any unopened glass or metal container of food in the fireplace. Pressure may build up and cause the container to burst, possibly resulting in serious personal injury or damage to the fireplace.
- Never line fireplace with aluminum foil.

## Maintenance and Repair

- Spiders and other insects can nest in the burners and block the gas and airflow to the burner ports. This creates a dangerous condition that can result in a fire from behind the valve panel. Inspect and clean the burners periodically and follow the guidelines in the maintenance section of this manual.
- The appliance should be inspected before use and at least annually by a qualified service person.
- More frequent cleaning may be required as necessary. It is imperative the control compartment, burner and circulation air passageways of the appliance be kept clean and free.
- Any guard or other protective device removed for servicing the appliance must be replaced prior to operating the appliance.
- If it is evident there is excessive abrasion or wear of any of the components, if the fuel supply hose is cut or cracked, it must be replaced prior to the appliance being put into operation.
- Inspect the fuel supply connection for signs of leakage (including the hose for propane models) before each use of the appliance.
- Unless specifically recommended in this manual, do not repair or replace any part of your fireplace. Have a qualified technician perform all service. Any repairs made by a non-LMS approved dealer technician will void your warranty.

### Storage

- When your fireplace is not in use, turn off the gas at the source.
- Do not store the propane cylinder in the vicinity of this or any other appliance when it is not being used.
- This appliance can be store indoors only if it has been disconnected from its fuel supply.
- Store propane cylinders outdoors in a well-ventilated area out of reach of children. Disconnected cylinders must have threaded valve plugs tightly installed and must not be stored in a building, garage, or any other enclosed area.
- To extend the life of your fireplace, protect and cover it from the elements when not in use. Ensure the appliance has ample time to cool off after use and prior to installing storage cover. Damage caused to storage cover due to heat or burns are not covered by warranty.

### Precautions Regarding Children

- Never leave children unattended in the area where the fireplace is being used. Close supervision of children is necessary when any appliance is used near children.
- Do not store items of interest to children around or below the fireplace.
- Never allow children to sit or stand on any part of the fireplace.

# Installation / Assembly

Most cities and counties require permits for exterior construction and electrical circuits. In addition, some communities have codes requiring residential barriers such as fencing and/or self-closing gates on property to prevent unsupervised access to the property by children under the age of 5. Your dealer can provide information on which permits may be required and how to obtain them prior to the delivery of your equipment.

**Installation and service must be performed by a qualified installer, service agency or your natural gas or liquid propane gas provider.**

## Set-Up

You are responsible for ensuring that a natural gas line (if required) is installed and safe for use. We recommend that a licensed contractor install your fireplace. Installation must conform to local codes, or in the absence of local codes, with either the *National Fuel Gas Code, ANSI Z223.1 / NFPA54, Natural Gas and Propane Installation Code, CSA B149.1, or Propane Storage and Handling Code, B149.2*, as applicable.

To prevent fire and smoke damage, remove all packaging material before operating the fireplace.



**WARNING!** Proposition 65 Warning: Handling the brass material on this product exposes you to lead, a chemical known to the State of California to cause cancer, birth defects or other reproductive harm. (Wash hands after handling this product.)

This product and the fuels used to operate this product (propane or natural gas), and the products of combustion of such fuels, can expose you to chemicals including Benzene, which is known to the state of California to cause cancer and birth defects or reproductive harm.

For more information go to [www.P65Warnings.ca.gov](http://www.P65Warnings.ca.gov).

## Placement and Location

### Cal Flame fireplaces are designed for outdoor use only.

- Never locate this appliance in a building, garage, or any other enclosed room or under a sealed overhead structure, or in any type of enclosed area such as a garage, shed, or breezeway. Keep clear of trees and shrubs.
- Do not place fireplace under or near windows or vents that can be opened into your home.
- Maintain sufficient distance as to not overheat any overhead combustible material such as a patio cover.
- The area surrounding your fireplace should be kept clean and free from flammable liquids and other combustible materials such as mops, rags or brooms, as well as solvents, cleaning fluids, and gasoline.
- Do not block the vents located near the base of your fireplace as gas may build up in case of leak and cause serious damage.
- Do not install or operate your fireplace in such a manner that the cross ventilation openings are blocked. Fresh air must be able to pass through installed vents to safeguard against residual gas accumulation. Failure to allow proper ventilation may cause fire or explosion.
- Do not locate appliance where it can get excessively wet. Do not use this appliance if any part has been underwater. Immediately call a qualified service technician to inspect the unit and to replace any part of the control system and any gas control which has been underwater.
- Place your fireplace on a flat and stable surface in an outdoor location such as a patio deck.
- Locate your fireplace adjacent to the gas supply line (liquid propane or NG), preferably with the shortest gas line run possible.
- Maintain the following clearances to combustible materials on all Cal Flame fireplaces.

Sides and back      48 inches (122 cm) (measured from side)

Top                      120 inches (305 cm) (measured from hearth)



## Leak Testing Procedure

Perform a leak test at least once a year whether the gas supply cylinder has been disconnected or not. In addition, whenever the gas cylinder is connected to the regulator or whenever any part of the gas system is disconnected or replaced, perform a leak test.

As a safety precaution, remember to always leak test your fireplace outdoors in a well-ventilated area. Never smoke or permit sources of ignition in the area while doing a leak test. Do not use a flame, such as a lighted match to test for leaks. Use a solution of soapy water.

1. Prepare a leak testing solution of soapy water by mixing in a spray bottle one part liquid soap to one part water.
2. Make sure all the control knobs are in the OFF position.
3. Turn on the gas.

On **natural gas systems**, turn the main feed valve to the burner.

On **propane systems**, turn the cylinder valve knob counter clockwise one turn to open.

4. Apply the leak-testing solution by spraying it on joints of the gas delivery system. Blowing bubbles in the soap solution indicates that a leak is present.
5. Stop a leak by tightening the loose joint or by replacing the faulty part with a replacement part recommended by the manufacturer. Do not attempt to repair the cylinder valve if it is damaged. The cylinder must be replaced.
6. Turn the control knob back to the full OFF position.

If you are unable to stop a leak:

1. Turn the control knob back to the full OFF position.
2. Shut off the gas supply to the fireplace and release pressure in the hose and manifold by turning the control valve one quarter turn counter-clockwise.
3. On propane systems, remove the cylinder from the fireplace.
4. Call an authorized gas appliance service technician or an liquid propane gas dealer.

Do not use the appliance until the leak is corrected.

## Liquid Propane

Your Cal Flame fireplace is not provided with a propane cylinder. If you choose to operate your fireplace with propane, you must supply your own cylinder.

### Requirements

The 20 lb propane gas supply cylinder used with propane models must be constructed and marked in accordance with the specifications for propane gas cylinders as required by the U.S. Department of Transportation (DOT) or the CAN/CSA B339, Cylinders, Spheres and Tubes for the Transportation of Dangerous Goods.

**Manifold Pressure:** For plumbed-in liquid propane installation, use a regulator.

**Supply Pressure:** Maximum line pressure for plumbed-in propane is 14" W.C. psi (3.5 kPa). Minimum line pressure for propane is 11" W.C.

**Pressure Regulator:** The unit must be used with the supplied gas pressure regulator and hose assembly. The regulator will control and maintain a uniform gas pressure in the manifold. The burner orifice has been sized for the gas pressure delivered by the regulator. Replacement pressure regulator and hose assemblies must be those specified in this manual.

**Cylinder Specification:** Any propane gas supply cylinder used with this fireplace must be approximately 12 inches in diameter and 18 inches high. The maximum fuel capacity is 20 lbs. of propane, or 5 gallons. Full cylinder weight should be approximately 38 lbs. (43.7 lbs. nominal water capacity.) Always use the cylinder dust cap on the cylinder valve outlet during transport and when the cylinder is not connected to the fireplace. The 20 lb propane gas cylinder used must include a collar to protect the cylinder valve.

**Filler Valve:** If you do not have an updated filler valve on your existing propane tank, you will need to purchase one at your local hardware store, as you will not be allowed to refill the tank at any filling station.

**Transporting Gas Cylinder:** Only one cylinder should be transported at a time. Transport cylinder in an upright and secure manner with control valve turned off and the dust cap in place.



**Connection**

Check the rating plate to make sure the gas supply you are hooking up to is the gas type the fireplace is manufactured for.

Inspect the hose shipped with the unit for damage. Never attempt to use damaged or plugged equipment. See your local liquid propane gas dealer for repairs. After inspecting the propane hose shipped with the unit, connect the end with the female fitting on the hose to the male fitting on the on/off gas valve at the end of the hose. Tighten fittings using two wrenches.

When connecting the regulator assembly to the tank valve, hand tighten the black QCC-1 nut clockwise. DO NOT use a wrench to tighten. See the figure below.

Purge the gas supply line of any trapped air prior to the first firing of the unit.

During the initial purging and subsequent lightings, NEVER allow gas to remain in the "Open" position without first placing and igniting the fire starter.

Be certain to mount or set the 20 lb propane gas cylinder on a flat surface and restrain it to prevent it from tipping.

Locate the hose out of the pathways where people may trip over it or in areas where the hose may be subjected to accidental damage.

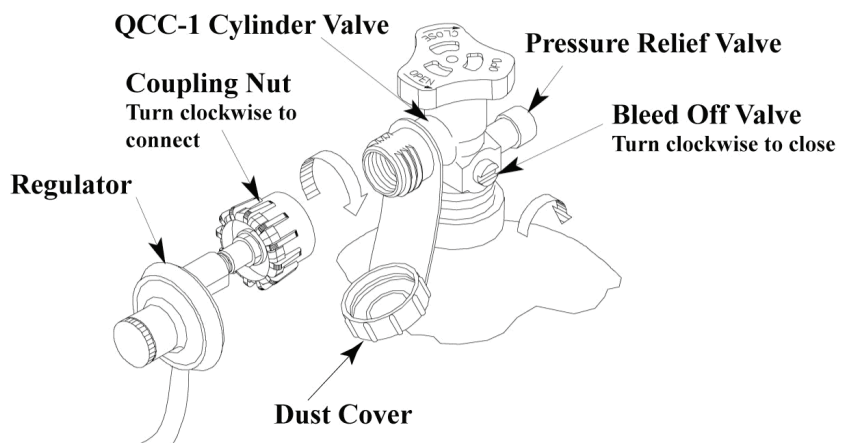

## Propane Cylinder Enclosure

Cal Flame fireplaces do not have an enclosure for the propane cylinder. If you build an enclosure for a propane gas cylinder, follow these recommended specifications and follow local codes.

Ensure cylinder valves are always readily accessible. A door on the enclosure to gain access to the cylinder valve is acceptable, provided it is non-locking and can be opened without the use of tools.

Enclosures for propane gas supply cylinders need to be ventilated by openings at the level of the cylinder valve and at floor level. This is accomplished by one of the following ways:

- 1) One side of the enclosure is completely open.

This method has no special ventilation requirements.

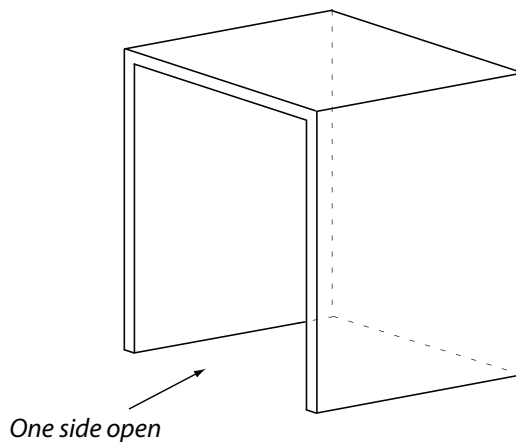

2) All sides are completely enclosed.

This method requires at least two ventilation openings at cylinder valve level in the side wall, equally sized, spaced at 180 degrees (3.14 rad), and unobstructed.

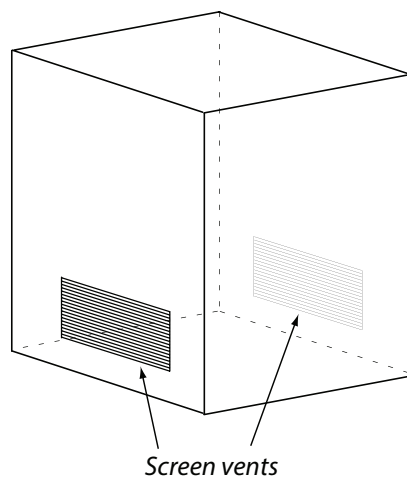

Make sure each opening has a total free area of not less than  $\frac{1}{2}$  square inch per pound (3.2 sq. cm/kg) of stored fuel capacity and not less than a total free area of 10 square inches (64.5 sq. cm).

Ventilation openings need to be provided at floor level with a total free area of  $\frac{1}{2}$  inch per pound (3.2 sq. cm/k) of stored fuel capacity and not less than a total free area of 10 square inches if the ventilation openings at floor level are in a side wall, make sure there are at least two openings. The bottom

of the openings shall be at floor level and the upper edge no more than 5 inches (127 mm) above the floor. The openings need to be equally sized, spaced at 180 degrees (3014 rad) and unobstructed.

Make sure every opening has minimum dimensions to permit the entrance of a  $\frac{1}{8}$  inch (3.2mm) diameter rod.

There shall be a minimum clearance of 2 inches (40.8mm) between the lower surface of the floor and the propane gas supply cylinder enclosure and the ground.

## Natural Gas

Ensure that the service supplying the fireplace is fitted with a conveniently positioned shut off valve with easy access. The shut off valve **MUST NOT** be inside the appliance!

### Requirements

Always check the rating plate to make sure the gas supply you are hooking up to is the gas type the fireplace is manufactured for.

The installation of this appliance must conform with local codes or, in the absence of local codes, to the national fuel gas code, ANSI Z223.1a-1998. Natural gas connection must be performed by a licensed contractor or local gas company representative.

Ensure that the service supplying the fireplace is fitted with a conveniently positioned shut off valve with easy access.

### Installation

Connect the incoming gas supply line to the on/off gas valve of the appliance. Make certain ALL gas connections are tight, turn the on/off valve at the unit to the 'on' position and use soap and water to test for leaks. Gas will be released at the burner for this duration. **DO NOT USE AN OPEN FLAME AND REMOVE BATTERY FROM IGNITER BEFORE PERFORMING THIS TEST. *An authorized gas appliance installer must provide this installation service.*** Note that the correct natural gas orifice must also be installed prior to fuel line hook up to maintain proper flame height and clean burn of fuel.

## Fireplace Burner Installation

This procedure describes how to access the gas lines for installation. **Gas installation should be performed by a qualified contractor.**

1. Remove the burner from the hearth. It is not connected and will lift out easily.



2. Remove the right side refractory wall from the fireplace by removing the 4 screws.



See Page 17.

3. Connect the flex line to the burner.

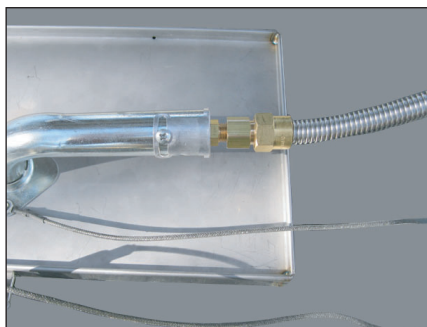

Installation / Assembly

- 4. Slide the flex line and the black sparker wires into the gap in the hearth base.



- 5. Reach through the gap in the open right side and pull the flex line and black sparker wires.



- 6. Connect the black sparker wires to the valve as shown below.

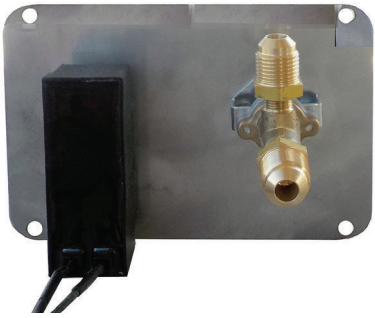

- 7. Connect the flex line from the burner to the gas valve as shown below.

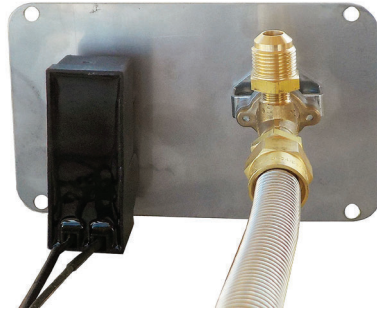

- 8. Push the black gas line (for propane units) or flex line (for NG units) under the fireplace.

*Make sure the burner has been converted for use with NG before connecting to a NG source!*





- 9. Connect the LP or NG gas source gas line to the gas valve as shown below.

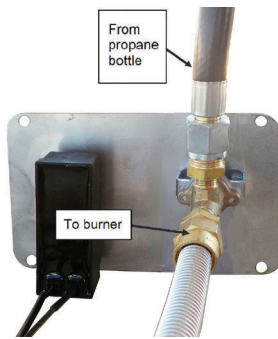

- 10. Replace the right side refractory wall.



- 11. Unscrew the push button switch and insert the battery in the starter.



Caution! Never place or store the propane tank under the hearth base!



## Locating the screws that secure the refractor wall



When you stand in front of your new outdoor fireplace, this is what you will see. While the unit appears solid, both the bottom and side panels are removable to allow propane tank connection access.

The removable side panel (side refractory wall) is located to the right when you are facing the fireplace.

There are 4-6 Phillips head screws that hold the side panel up. You will need to remove these screws to access the gas valves prior to using your new fireplace.

The picture below shows the location of the screws along with white plastic bushings provided to make the screws easier to locate prior to the side refractory wall removal. The screws are located in the top left/ top right/ bottom left/ bottom right on the panel.



The picture to the left shows one of the screws without the plastic bushing.

After you remove the plastic bushings you can remove the screws. The bushings are for shipping only. Do not put them back after your fireplace is set up. Once you have removed all the screws in the side wall, you will be able to tilt the panel forward allowing you access to the fireplace fuel line connections.



Once you successfully remove the screws, you will be able to carefully tilt the side panel forward.

Please refer to instructions on pages 12 - 15 for gas line hookup.

**Gas installation should be performed by a qualified contractor.**

## Fireplace Log Set Placement

The log set, log grate and crushed lava rock are shipped together on applicable models. Remove the log set and unpack all components. The logs are fragile -- use care when handling.

Once the fireplace is in position, level and safely hooked up to the proper fuel supply, install the log grate over the plate burner.

Place the lava rock around the flat burner plate. DO NOT place the lava rock on the burner plate as it will affect the flow of the flame.

Place the ceramic fire logs on the grate. Start by laying one log in the center of the grate length wise.

Lay the other logs (quantity may vary by unit type) over the first log

**NOTE: Be sure unit is cool before touching any of the components.**

## High Elevation Installation

Your fireplace is approved for elevations up to 4,500 feet in the US and Canada.

When installing this appliance at an elevation above 4,500 feet in the US, it may be necessary to decrease the input rating by changing the existing burner orifice to a smaller size. Reduce the input by 4% for each 1,000 feet above sea level, unless the heating value of the gas has been reduced, in which case this general rule will not apply. To identify the proper orifice size, check with your local gas utility.

When installing this unit at an elevation above 4,500 feet in Canada check with your local authorities. Consult the local gas utility for assistance in determining the proper orifice for your location.

## Natural Gas Conversion

**CAUTION:** This service is to be completed only by an authorized gas appliance installer. Do not attempt this conversion on your own as there is risk of serious injury or death.

### To The Authorized Gas Appliance Installer:

All Cal Flame fireplaces are shipped from the factory equipped to burn on liquid propane fuel. Enclosed with this kit is a natural gas conversion kit for converting this unit to natural gas. To perform this conversion, follow the directions below and to the local regulation standards in your area.

1. Make sure unit is not in operation and is cool enough to perform this service. Shut off and disconnect propane fuel source at the regulator end.
2. Carefully remove the storage cover, lava rocks and fire logs. Turn unit over to access hose connections underneath.
3. While holding the propane orifice in place with a wrench, unscrew brass fitting on fuel inlet hose. Unscrew propane orifice and remove.
4. Using the new brass natural gas orifice re-install the parts in the same sequence. Turn the protective screen / air intake sleeve to allow a controlled amount of air flow through the screen and into the fuel supply tube. Flame should have good retention. For a proper

burn and as a general rule, the air shutter for propane installation should be completely open, and the air shutter for NG installation should be mostly closed. This can be adjusted later to create a clean and desired flame.

5. Refer to photo below for proper placement of parts. The washer should insert next to the protective screen cover, then the spring is to be aligned with the hole and finally the natural gas orifice is to be threaded into the end of the fuel inlet leading into the burner. Once tight the other brass fitting connection can be made from the fuel line fitted between the valve and the orifice.
6. Connect natural gas supply hose (not included with kit) from supply source. Test for leaks.
7. Once the conversion is completed and leak tested, reload the fireplace with the lava rocks and fire logs. Test the unit while in place and verify it works properly. If flame from burner is not properly adjusted you can adjust air intake by turning the protective screen cover and air intake sleeve on the fuel supply tube.

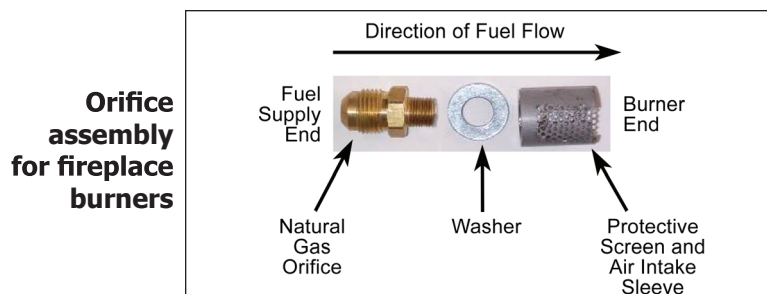

## Operation

**WARNING: DO NOT use solid fuel, such as wood or charcoal, in a gas fueled fireplace.**

Upon completing the gas line connection, a small amount of air will be in the lines. When the first lighting the burner, it will take a few seconds for the lines to purge themselves of this air.

Once the purging is complete, the burner will light and operate as indicated in the instruction manual. Subsequent lighting of the appliance will not require purging unless the gas supply has been disconnected.

Inspect the burner before each use of the appliance. If there is any evidence that the burner is damaged, it must be replaced before operating. Upon completing the gas line connection, a small amount of air will be in the lines. When first lighting the burner, it will take a few minutes for the lines to purge themselves of this air. Subsequent lighting of the appliance will not require such purging.

Never allow the ON / OFF valve to remain in the open position without placing a burning match on top of the burner **FIRST!**

You must have clear and easy access to the ON / OFF valve **AFTER** the appliance is installed and connected to the gas supply in order to safely turn off the burner.

Make sure the burner is in place prior to using the appliance. If the burner is damaged, install a replacement burner as specified by the manufacturer.

### For your safety, read before lighting.

- Before operating smell all around the appliance area for gas odors and next to the floor because some gases are heavier than air and will settle on the floor.
- Use only your hand to turn the manual gas control valve. Never use tools. If the valve will not turn by hand, do not try to repair it. Call a qualified service technician. Force or attempted repair may result in a fire or explosion,
- Do not use this appliance if any part has been under water. Immediately call a qualified service technician to inspect the appliance



**If you do not follow these instructions exactly, a fire or explosion may result, causing property damage, personal injury, or loss of life.**



and replace any part of the control system and any gas control which has been under water.

- Make sure the ignitor battery has been installed properly. Ignitor will not operate properly without a battery installed.

### Lighting Instructions for Automatic Starter

1. Remove protective storage cover and locate the manual gas control valve and igniter button on the fireplace.
2. Make sure fuel supply is properly connected and turned on at the source.



3. Depress igniter button until you hear it sparking. You will hear a small popping noise. Keep igniter button pushed in while slowly turning the fuel flow valve to the full flow position at the fireplace. The fireplace should light within 5 seconds. If you do not hear the igniter sparking you may need to replace the battery. The starter uses one standard AAA battery, located directly behind the rubber push button knob. (Unscrew knob to access battery.) Note some models ship with the batteries removed or may not be included with your model.
4. If a flame does not start within 10 seconds, shut off all gas supply and wait five minutes to allow all gas fumes to clear. Re-try or go to trouble-shooting and start again from step 1.

### To Turn Off Gas

Turn the ON/OFF valve to the off position at the unit for natural gas unit. For propane unit, turn the ON/OFF valve to the OFF position at

the unit and then turn the valve on the propane tank to the OFF position clockwise.

**NOTE**

The propane regulator in this appliance is equipped with a low flow protection device. Unless the propane cylinder valve is opened before the valve, the gas flow will be reduced resulting in a very small flame.

To reset this device, shut off the valve, disconnect the hose from the cylinder to relieve the pressure, then close the propane cylinder valve.

Follow the lighting procedure ensuring the propane cylinder valve is opened before the unit is.

## Cleaning and Maintenance

Inspect the appliance before initial use. Clean the appliance at least annually and have it inspected by a qualified field service person.

Periodically remove the logs and examine the burner. If the burner is dirty, clean it with a soft wire brush. Also examine the area around the burner air shutter. Remove any dirt or debris in this area. This will ensure long life and trouble-free operation.

Periodically check the hose connecting the propane gas cylinder to ensure it is not damaged in any way.

Carbon (soot) may build up on the surfaces of the logs with heavy use. This is more likely to occur with propane gas. Clean soot off the surface of the logs periodically to prevent excessive buildup.

To clean the logs, be sure the fire is out, the gas supply is turned off and the logs are cool to the touch. The soot can then be brushed off with a dry bristle brush or cloth. Take care while cleaning the logs as they can become damaged if mishandled.

Periodically check the hose connecting the propane gas cylinder to ensure it is not cracked or damaged in any way. All natural gas hook-ups should be serviced and inspected only by qualified installers only.

The easiest way to clean the fireplace is to let the fireplace cool completely off. Spray the enclosure off with water. Note: Do NOT spray water directly onto the burner.



**WARNING!** Proposition 65 Warning: Handling the brass material on this product exposes you to lead, a chemical known to the State of California to cause cancer, birth defects or other reproductive harm. (Wash hands after handling this product.)

This product and the fuels used to operate this product (propane or natural gas), and the products of combustion of such fuels, can expose you to chemicals including Benzene, which is known to the state of California to cause cancer and birth defects or reproductive harm.

For more information go to [www.P65Warnings.ca.gov](http://www.P65Warnings.ca.gov).

## Replacement Parts

Call **1-800-225-7727** for any replacement parts not listed below. Be sure to have model name and number available.

Replacement parts shown below are listed first as complete assemblies with individual parts that can be ordered separately.

|   |             |
|---|-------------|
| Fireplace burner valve assembly, with lava rock, 3/8" x 108" hose and propane regulator | BBQ07210012 |
| Fireplace rectangle burner assembly set of 4 pieces                                     | BBQ04100076 |
| Rectangle burner body 7.25" x 14.25" stainless steel                                    | BBQ04100089 |
| Orifice NG .125 1/4" flare  | BBQ04100077 |
| Orifice LP #43 1/4" flare   | BBQ04100078 |
| Flare fitting 3/8" male flare, 1/4" female flare  | BBQ04103047 |

# Specifications

|                                      | Propane Gas      | Natural Gas      |
|--------------------------------------|------------------|------------------|
| <b>Max. Input BTU/ Hr</b>            | 55,000           | 49,000           |
| <b>Orifice Size</b>                  | #43 (0.089)      | 1/8" (.125)      |
| <b>Manifold Pressure</b>             | 10" Water Column | 7" Water Column  |
| <b>Maximum Gas Supply Pressure</b>   | 11" Water Column | 14" Water Column |
| <b>Maximum Inlet Supply Pressure</b> | 13" Water Column | 14" Water Column |
| <b>Regulator Pre-Set</b>             | 11" Water Column |                  |

## Troubleshooting Fireplace and Fire Pit Igniter



*Before you start troubleshooting, make sure the gas valve on your propane tank is closed and the gas valve on the igniter is closed. Wait two minutes for any gas that may have accumulated to dissipate.*

**1. Check gas line connection.**  
Check the gas connection. Is it connected as shown in the example at right?

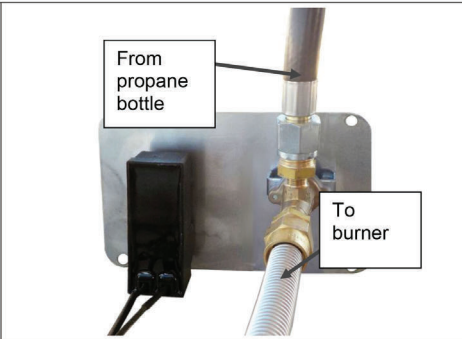







**YES.**  
Go to step 2.

**NO.**  
Reconnect the gas line tightly and conduct a leak test. Go to step 2.

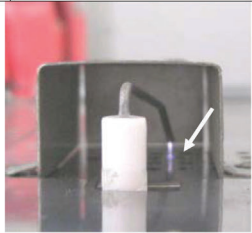
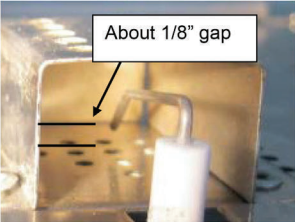
**2. Make sure the burner ignites.**  
Open the gas valve on the propane tank. Turn the gas valve on the igniter and listen for the gas. When you can hear the gas, light the burner with a long wooden match or a fireplace lighter. Does the burner ignite?



|  |  |
|--|--|
| <p><b>YES.</b><br/>Shut off the gas valve on the igniter.<br/>Go to step 3.</p>                          | <p><b>NO.</b><br/>Shut off the gas valve on the igniter and wait two minutes for any gas that may have accumulated to dissipate. Repeat until the burner ignites.<br/><b><i>Do not proceed to step 3 until you can manually light the burner.</i></b></p>  |
| <p><b>3. Listen for the igniter.</b><br/>Press and hold the igniter button. Do you hear the igniter?</p> |    |
| <p><b>YES.</b><br/>Go to step 4.</p>   | <p><b>NO.</b><br/>Make sure you have a fresh AAA battery in the igniter. Make sure it's not backwards.<br/>Go to step 4.</p>   |
| <p><b>4. Look for a spark.</b><br/>Press and hold the igniter button. Do you see the spark?</p>          |   |
| <p><b>YES.</b><br/>Go to step 5.</p>   | <p><b>NO.</b><br/><b>(1) Check for contact with metal.</b><br/>Make sure the igniter post is not touching metal. If it is, it will not spark. There must be a minimum 1/8" gap between the tip of the igniter and any metal surface. To adjust the igniter, use a 14mm wrench to adjust the two nuts on the mounting bracket under the burner.</p>   <p>Go to step 5.</p> |

|  |  |   |
|--|--|---|
|  | <p><b>(2) Check igniter wire connections.</b><br/>         Make sure the wires are correctly connected to the igniter terminals. If the connectors aren't connected properly, the spark may be arcing between them. Check the connections and go to step 5.</p>  |   |
| <p><b>5. Light the burner with the igniter.</b><br/>         Open the gas valve on the igniter.<br/>         Press and hold the igniter button. Did the burner ignite?</p> |  |  |
| <p><b>YES.</b><br/>         Place the burner in the recess in the fireplace or fire pit.</p>   | <p><b>NO.</b><br/>         Shut off the gas valve on the igniter and wait two minutes for any gas that may have accumulated to dissipate. Repeat steps 3 and 4.<br/><br/>         If you are unable to light the burner with the igniter after following these troubleshooting instructions, call Cal Flame customer service at 800-225-7727 for assistance.</p> |   |

## LIMITED WARRANTY

All Cal Flame models are manufactured with the highest quality appliances and are warranted to be free from defects in material and workmanship at time of delivery.

Direct any warranty issue with your grill via email to [customerservice@calflamebbq.com](mailto:customerservice@calflamebbq.com) or phone (800) 225-7727.

LMS warrants fireplaces and associated hardware from deterioration, corrosion, and defects in material and workmanship for a period of one year from the original date of delivery, with the exception of plastic items, which are warranted for 90 days.

### Extent of Warranty

This limited warranty is only valid on Cal Flame models delivered in the United States or Canada and extends through the selling dealer to the original purchaser at the original site of installation. This warranty becomes valid at time of delivery and ends either by specified time-frame listed above or upon owner transfer or relocation.

### Warranty Performance

In the event of a malfunction or defect covered under the terms of this warranty, contact either the selling dealer or a local contractor or service technician. Depending on your needs, this may be a contractor qualified to repair stone and tile or a service agent licensed to repair gas or electrical appliances.

In the event the consumer is unable to obtain satisfactory customer service from the selling dealer or service agent, written notification must be given to the LMS Customer Service Department within 30 days of the reported failure.

There will be no charge for parts on a covered item. Cost of labor is the responsibility of the owner. Shipping and handling charges will apply to all warranted replacement parts. The service agent may assess a reasonable travel or mileage charge per service call. If LMS determines that repair of a covered item is not feasible, LMS reserves the right to replace the defective merchandise with merchandise equal in value to the original purchase price. Warranty repair and / or replacement are the sole discretion of LMS and this warranty does not cover costs therein, including but not limited to: freight, removal, re-installation, etc.

This warranty is non-transferable and may not be extended beyond the above mentioned time frames under any circumstances, by any of LMS's representatives.



## Warranty Limitations and Exclusions

Grate and log set are not covered by this warranty.

This warranty is void if the fireplace has been subject to negligence, alteration, misuse, repairs, dings, dents, scratches, or incorrect and / or prohibited applications, as specified in the owner's manual. Gas lines must be installed by a licensed plumber only or local gas company agent. Incorrect electrical installation by unlicensed electricians, service by non-LMS authorized representatives, acts of God and other cases beyond the control of LMS are not covered by this warranty. Please refer to the owner's manual for examples of exclusions and common acts invalidating this warranty.

This limited warranty applies only to fireplaces and associated hardware used for personal, family, and outdoor household purposes. This warranty does not apply to labor charges, replacement parts and hardware. This limitation is retroactive and applies to all fireplaces and hardware manufactured from 2000 and hereafter.

Examples of common acts invalidating this warranty include but are not limited to:

- Use of fuel other than what is specified for the appliance (such as burning wood in a gas fireplace).
- Scratches caused by normal use.
- Damage caused by extreme weather conditions (hot, cold, etc.)
- Damage caused by dirt, sand, and/or water damage.
- Damage caused by continued operation of the fireplace with either known or unknown problems.
- Damage caused by direct sunlight.
- Damage caused as a result of failure to follow the operating instructions as defined in this owner's manual.

This limited warranty applies only to fireplaces normally used for personal, family, or household purposes and specifically excludes rental or commercial applications.

## Disclaimers

LMS shall not be liable for loss of use of the fireplaces, related hardware or other incidental or consequential costs, expense or damages, which may include, but are not limited to, removal of permanent deck

or other custom fixtures or the necessity for crane removal. Any implied warranty shall have duration equal of the applicable warranty stated above.

Natural stone: Rock, travertine, marble, etc. may be characterized by dry seams, pits, chips, cracks, and fossils that are often filled with grout during installation. These are normal imperfections and are not considered defects.

### **Legal Remedies**

This limited warranty gives you specific legal rights. You may have other rights, which may vary from state to state.

### **Customer Service**

For customer service, contact the authorized selling dealer immediately. If you need additional information or assistance, please contact the LMS Customer Service Department at 1462 E. Ninth St., Pomona CA 91766 or call (800) 225-7727.

See your Cal Flame dealer for a copy of the applicable warranty, details and any questions you may have regarding the warranty coverage on your product.

**CONTACT INFORMATION**

For customer service, please contact your authorized dealer immediately.  
If you need additional information and/or assistance, please contact:

**Cal Flame**

Customer Service Department

1462 East Ninth Street

Pomona, CA 91766

Toll Free: 1-800-225-7727

Fax: 1-909-629-3890

**[www.calflamebbq.com](http://www.calflamebbq.com)**

*Cal Flame*<sup>®</sup>



**WARNING!** Proposition 65 Warning: Handling the brass material on this product exposes you to lead, a chemical known to the State of California to cause cancer, birth defects or other reproductive harm. (Wash hands after handling this product.)

This product and the fuels used to operate this product (propane or natural gas), and the products of combustion of such fuels, can expose you to chemicals including Benzene, which is known to the state of California to cause cancer and birth defects or reproductive harm.

For more information go to [www.P65Warnings.ca.gov](http://www.P65Warnings.ca.gov).