

Option Placement May Vary

SEE NOTES BELOW FOR MORE INFORMATION

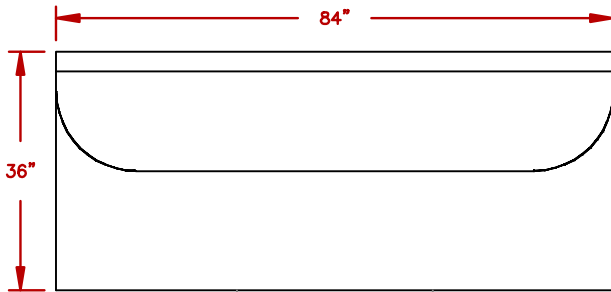

TOP VIEW

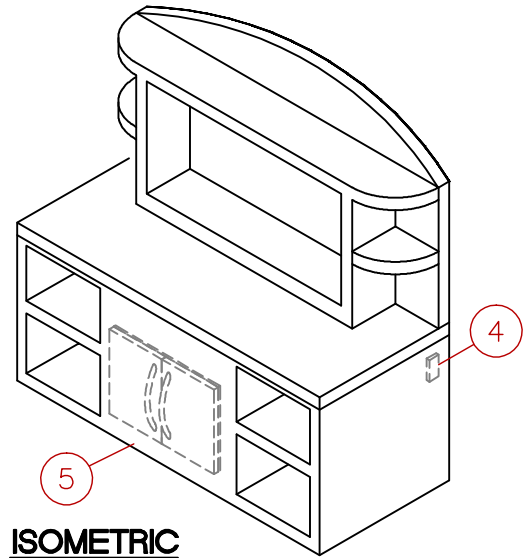

ISOMETRIC

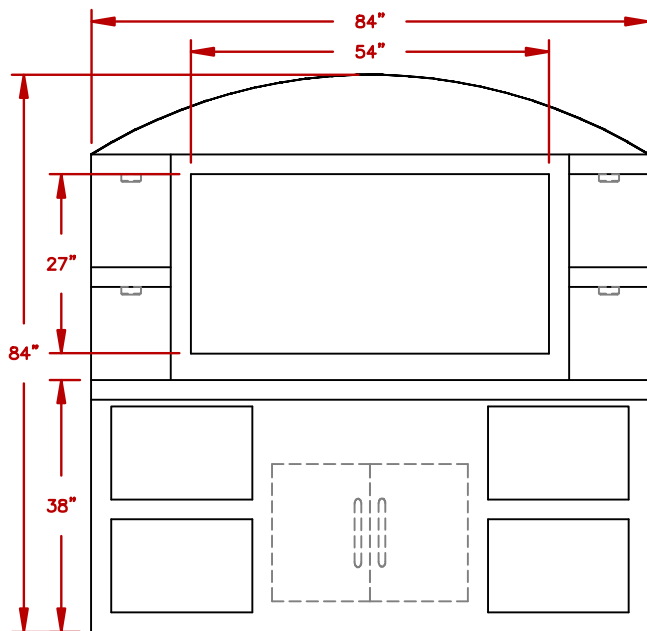

FRONT VIEW

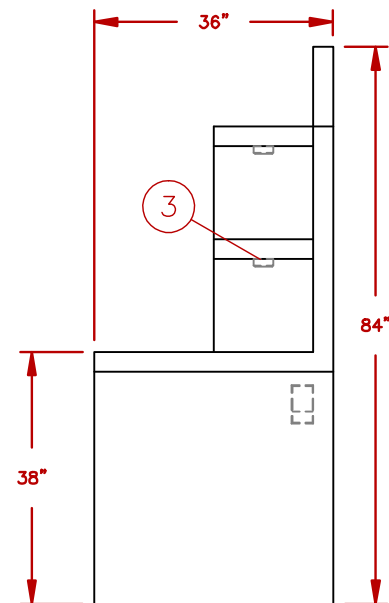

SIDE VIEW

STD FEATURES

ITEM	DESCRIPTION
1	PORCELAIN TILE 12 X 12 (FIELD) (BORDER)
2	AMERISTONE STUCCO STANDARD FINISH
3	4 EXTERIOR LED LIGHTS
4	EXTERIOR ELECTRICAL
5	30" STAINLESS STEEL ACCESS DOOR

NOTE:
DUE TO OUR CONTINUOUS IMPROVEMENT PROGRAM, ALL MODELS
AND SPECIFICATIONS ARE SUBJECT TO CHANGE WITHOUT NOTICE.

	TITLE 2019 BARBECUE LINE OUTDOOR ENTERTAINMENT ODC-2	
	SCALE:	DWG NO.
REVISED A	REV. DESCR.	DATE 11/9/18